



凌讯

— LX MICRO —

功率半导体器件制造商

Power Semiconductor Device Manufactures

用芯智造美好生活

Creat a better life with you heart Lingxun Microelectronics

Company Profile



Guangdong Lingxun Microelectronics is a national high-tech enterprise that focused on R&D, assembly and testing, sales of power semiconductor devices. Currently has more than 180 employees and more than 10000m² area. We provide over 600KK power semiconductor devices per annum.

We provide customers with high-quality, highly reliable power semiconductor devices and comprehensive technical support. We do have main product series include Schottky, FRD, LV Schottky, HV MOS, M&L Voltage MOS, Cool MOS, IGBT Singlediodes, and SiC, GaN Diodes etc. Widely used in various fields such as Power supplies, Battery management, Motor drive, LED lighting, smart home appliances, brushless Motors, inverters, etc.

Lingxun Microelectronics is committed to becoming an excellent manufacturer of power semiconductor devices. Cherishing every trust from customers, employees, and partners, and strive to provide sincere and enthusiastic service to customers!

Welcome you to visit our factory!



Factory Pictures



Production workshop

More than 8000m²



Office and dormitory

4000m²

Workshop pictures



Die saw



Die Bond



Wire Bond



Molding



Testing



Laboratory

The service we can provide



ODM

Original Design Manufacturer

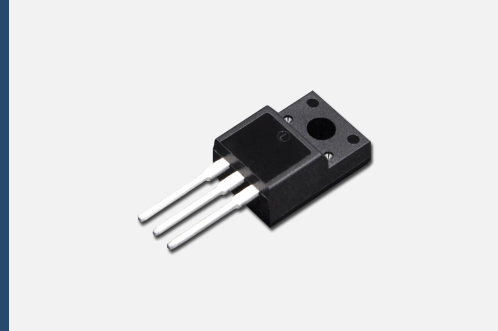

OEM

Origin Entrusted Manufacture

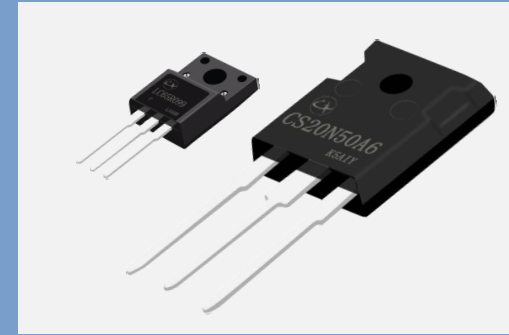







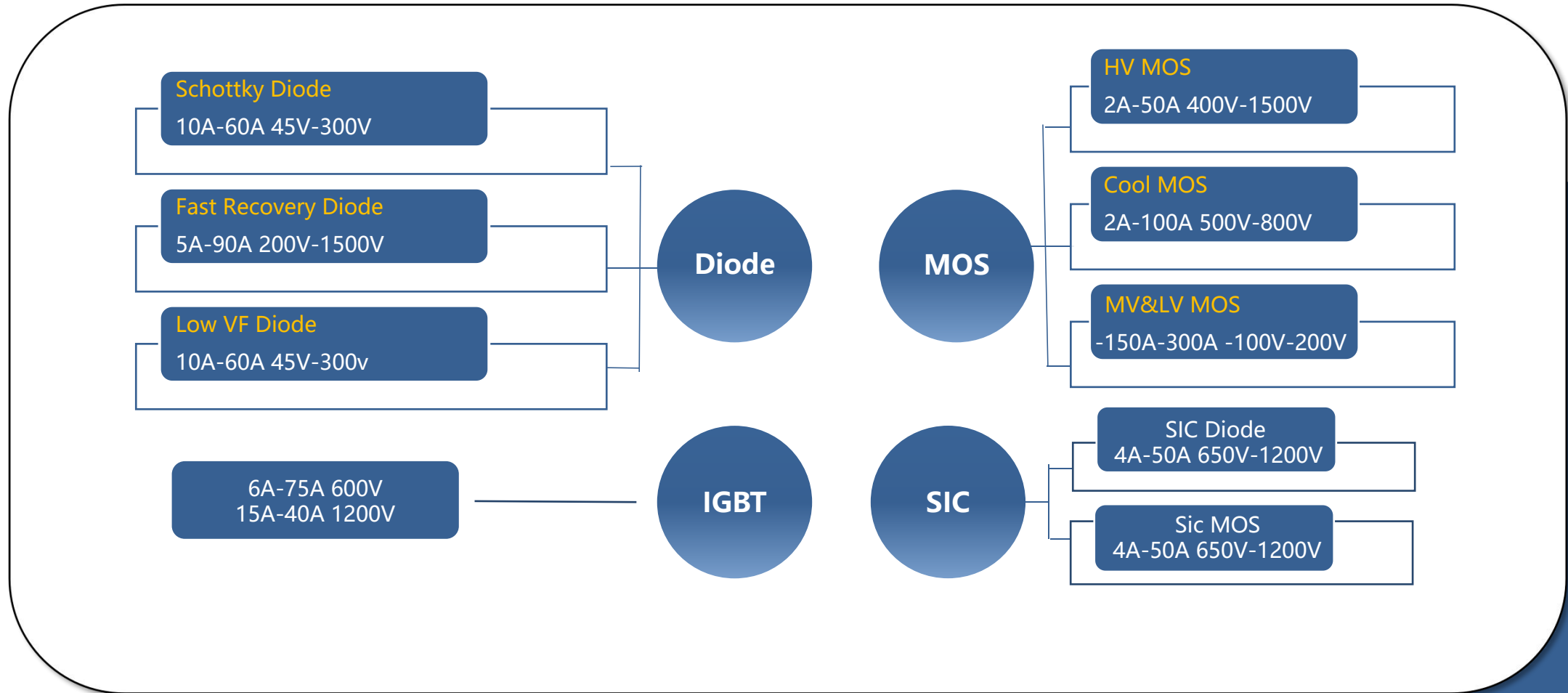

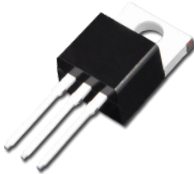
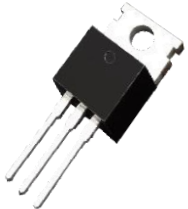

LX

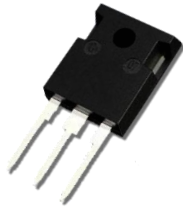
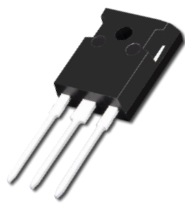
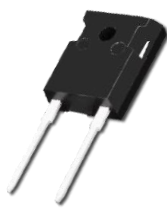
Lingxun Brand Promotion

Product Plan

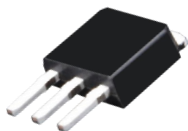

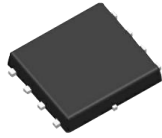
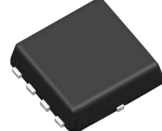
Package outline/Capacity of production

标准名称	TO-220F	TO-220AB	TO-220C	TO-220AC	TO-247S	TO-247	TO-247AC	TO-247-4
实物图								
月产能	20KK	8KK	4KK	4KK	4KK	2KK	2KK	2KK
标准名称	TO-262	TO-263	TO-263C	TO-251	TO-252	PDFN5*6	PDFN3*3	TOLL
实物图								
月产能	4KK	4KK	4KK	10KK	30KK	12KK	20KK	1.5KK

Quality Certification



Product Applications

Adapter



Battery



Motor





凌讯

— LX MICRO —

Lingxun Microelectronics

Thank you



Address : No.7,Xingrong Road,Shijie ,Dongguan City,Guangdong,China



Tel : 00861898872015 (Same to Wechat and Whatsapp)

www.lxmicro.com

